

図 1.1 世界の火山分布 [IAVCEI, 世界の活火山カタログ]



図 1.3 3種のプレート境界。二つのプレートが、(a)ぶつかり合う、(b)遠ざかる、(c)すれちがう。



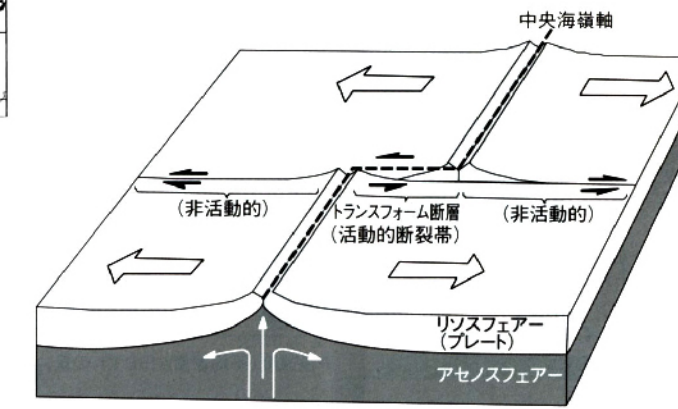
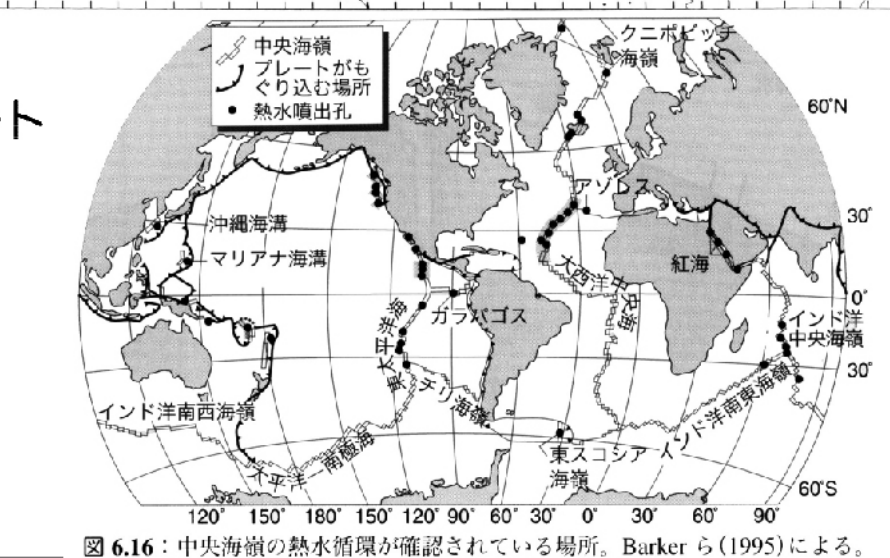
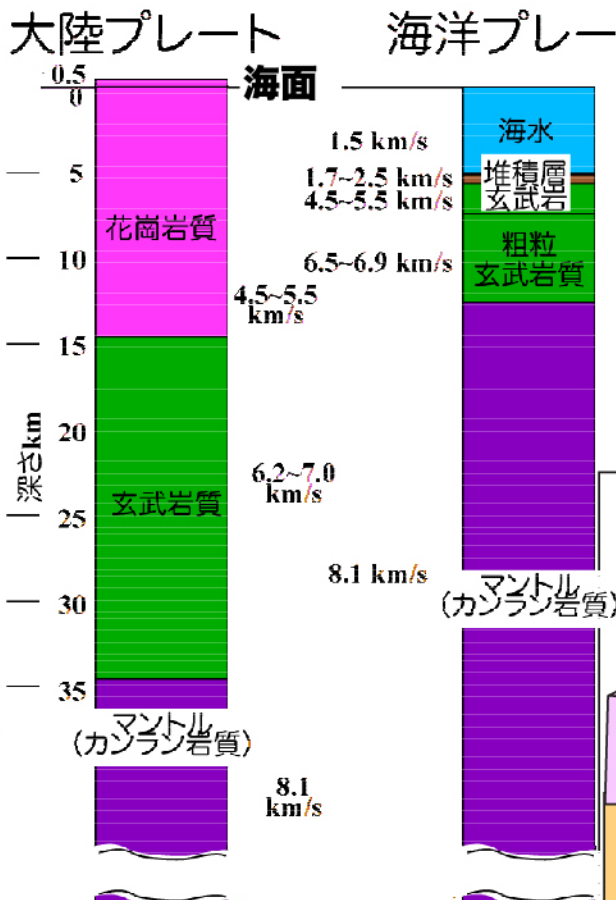
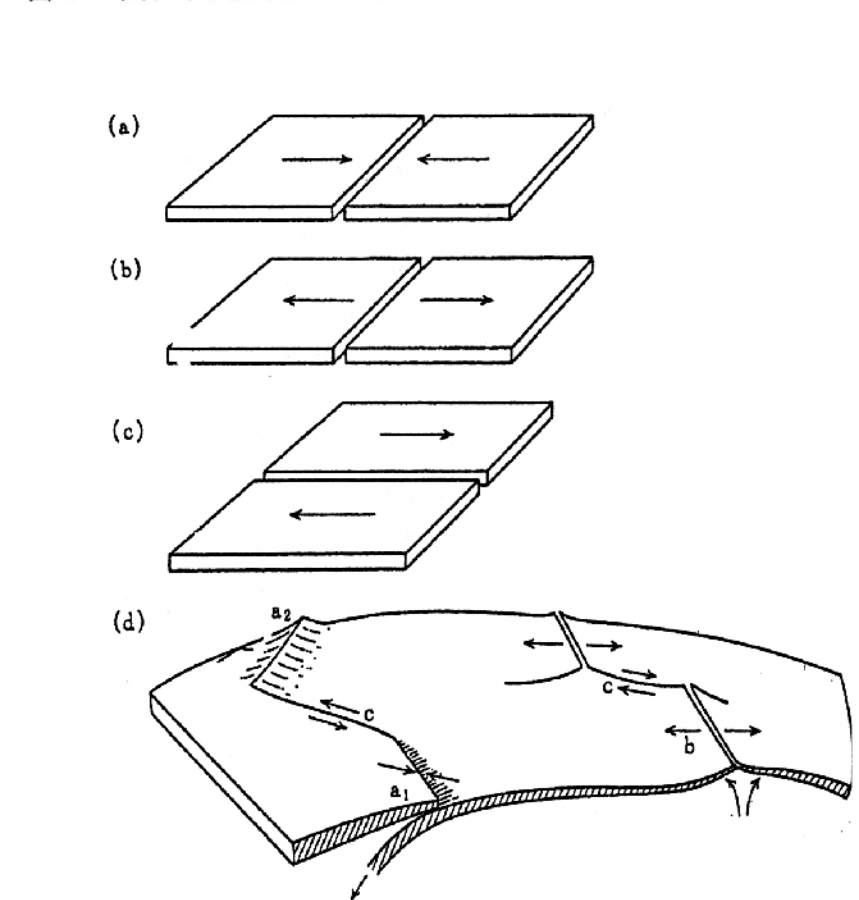
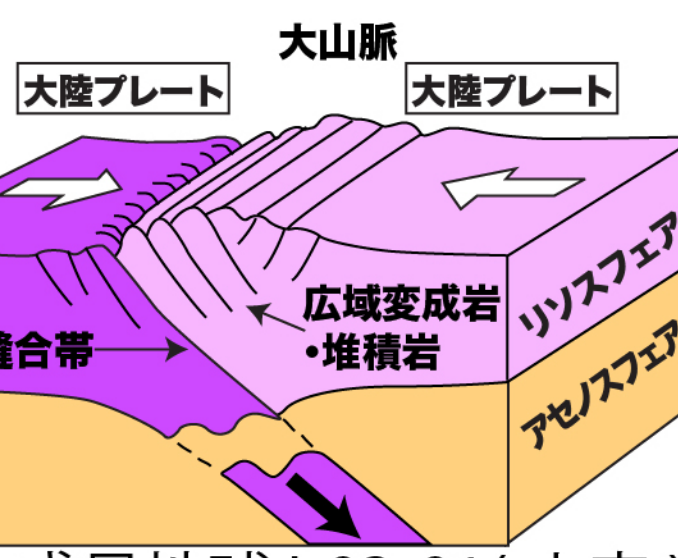
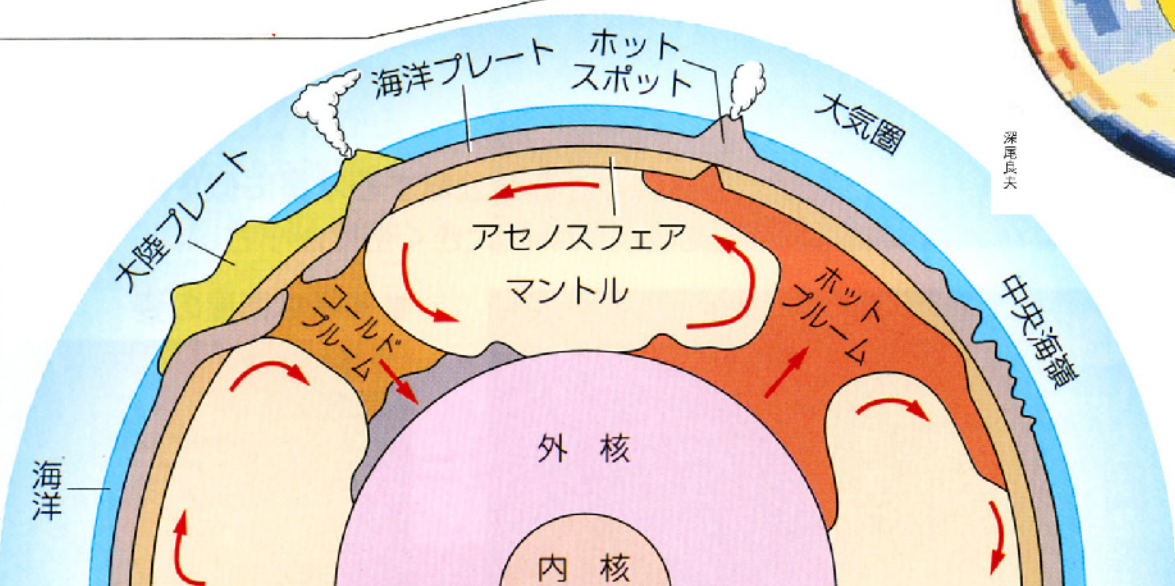
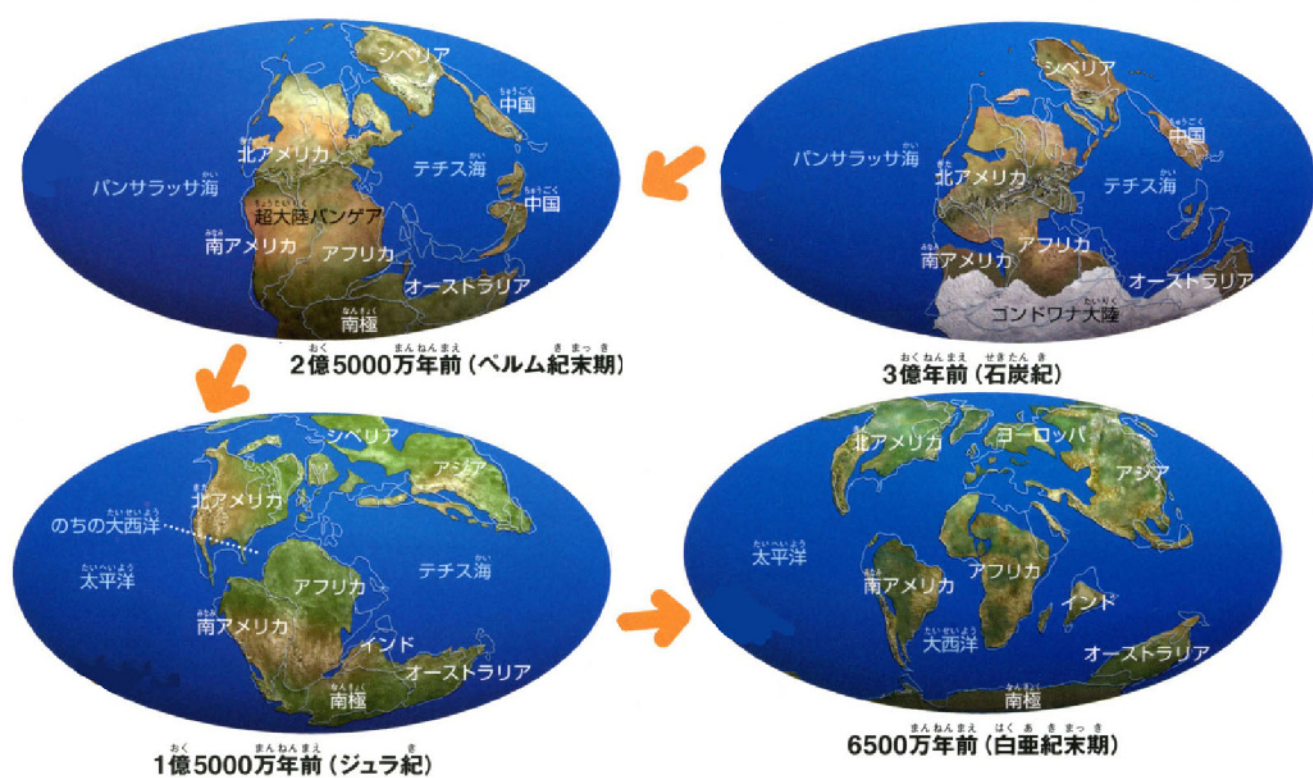
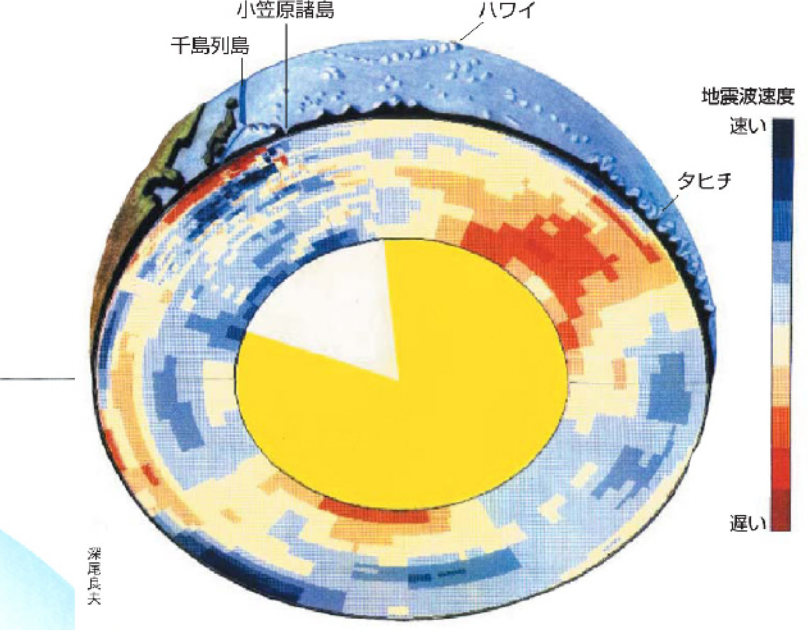
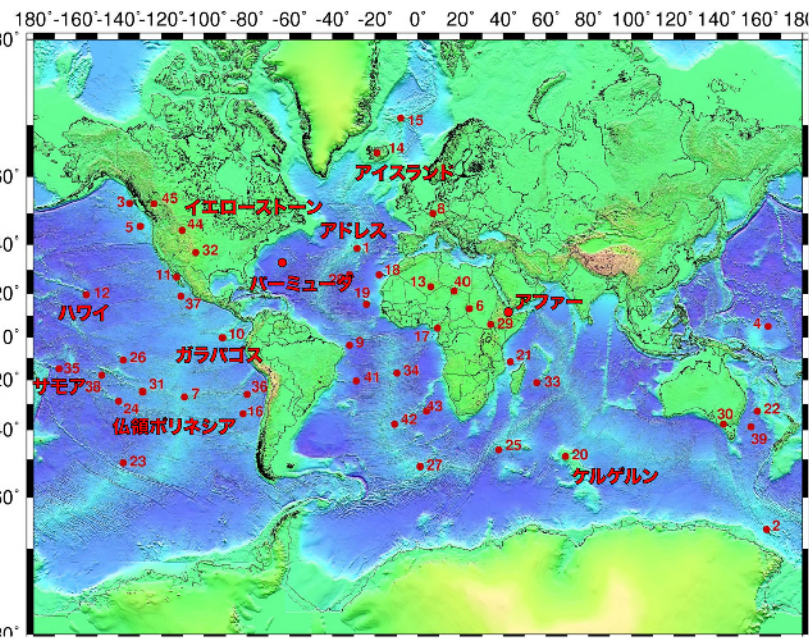
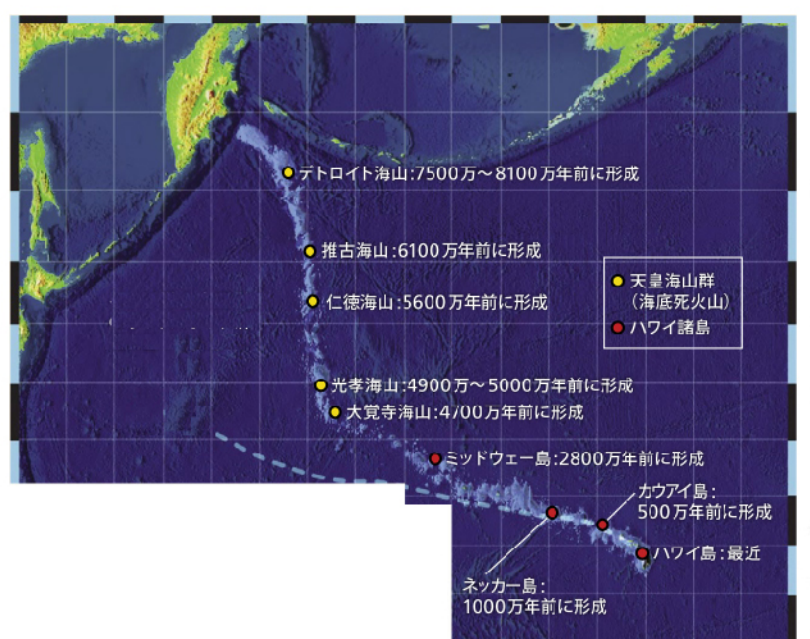
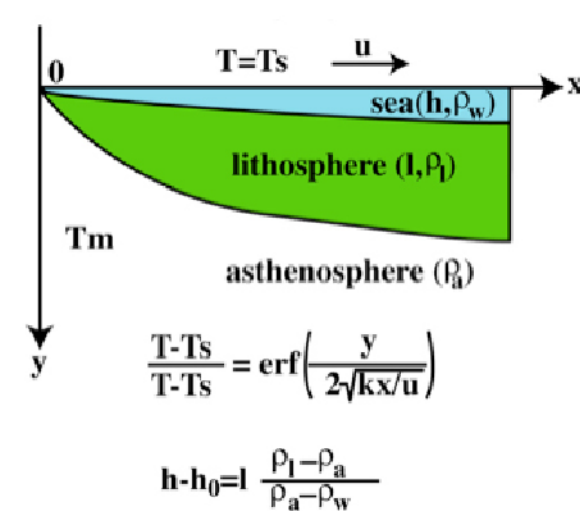
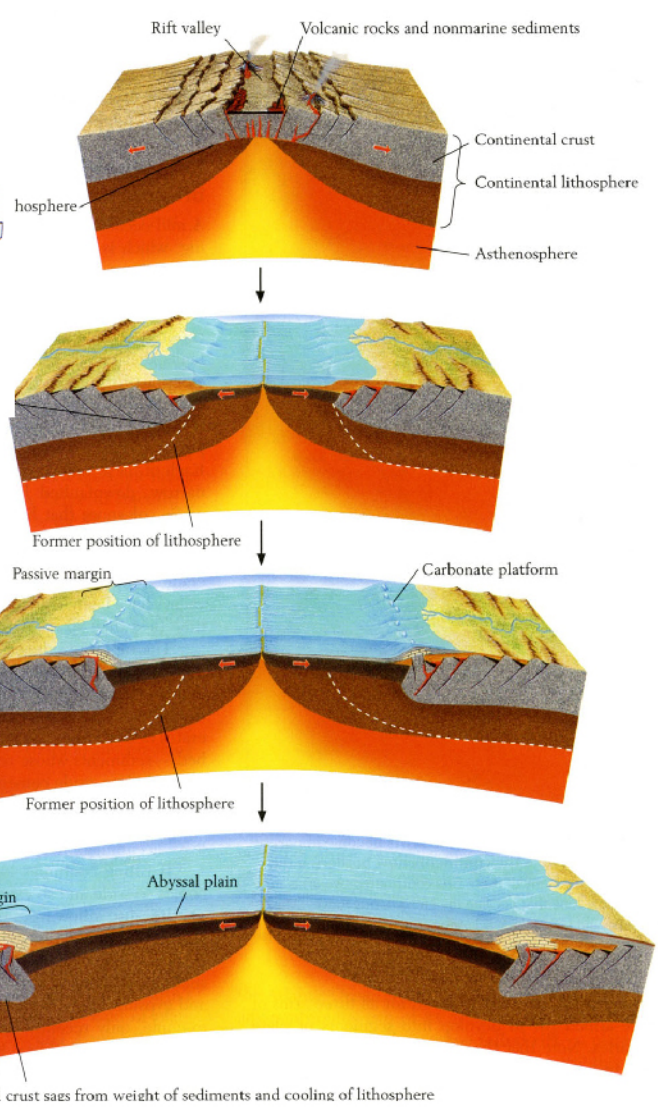
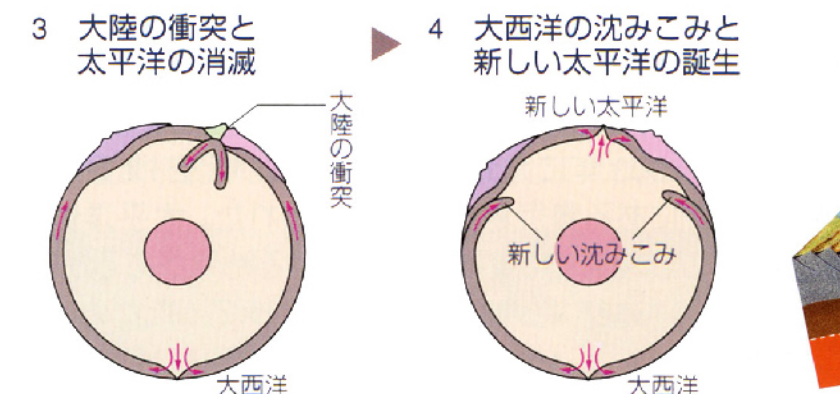
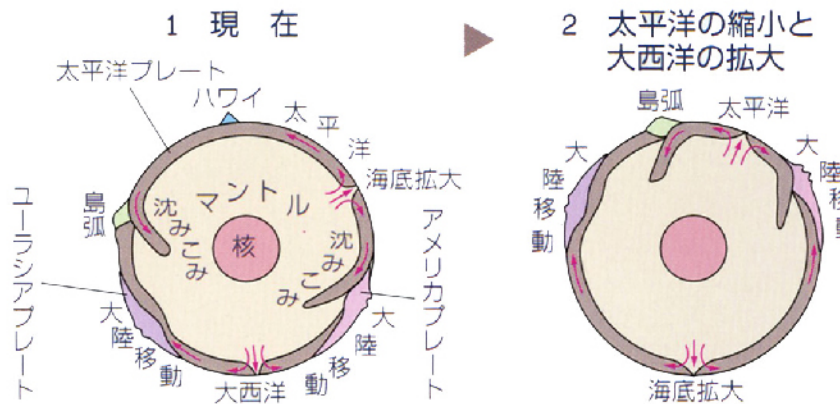
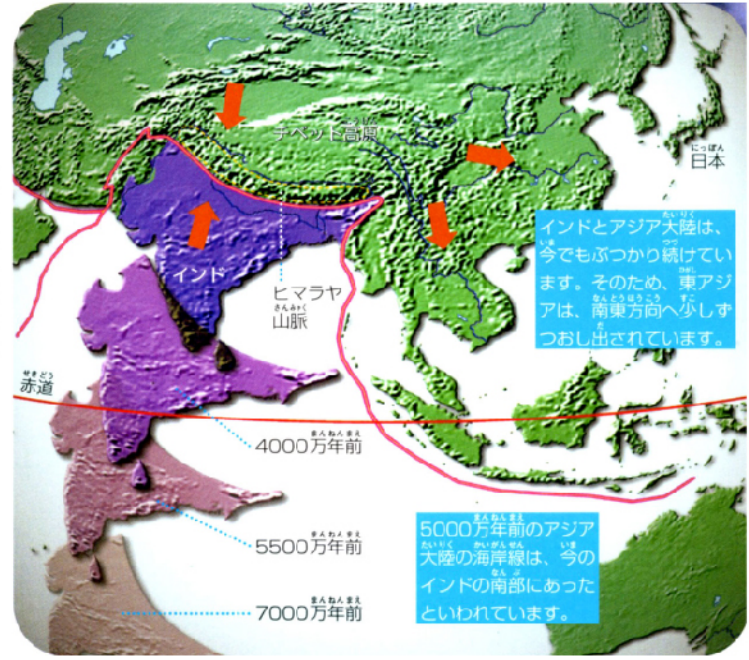
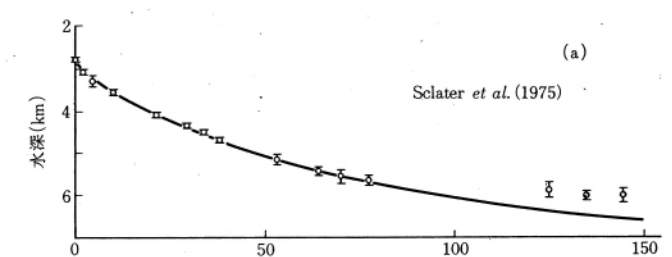
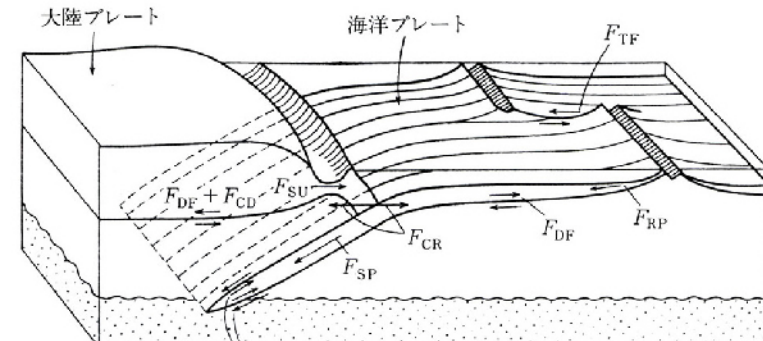

出典は以下のサイトを列挙
<http://ea.c.u-tokyo.ac.jp/earth/Members/komiya.html>
 惑星地球 I-03-02 (小宮剛)